

CUSTOM-BRANDED POST & RING



The full square tube construction of the Post and Ring offers a higher degree of security against pipe cutters than standard round tubing. Pair it with your custom design or logo and you've got the perfect marriage of bike rack form and function.

Product Specifications

- One point of installation and small footprint on the sidewalk
- Full square tube construction
- Accommodates two bikes
- Offers 2 points of contact for bike stability
- Meets APBP bike parking guidelines

CUSTOM-BRANDED Post & Ring

Recommended Setbacks

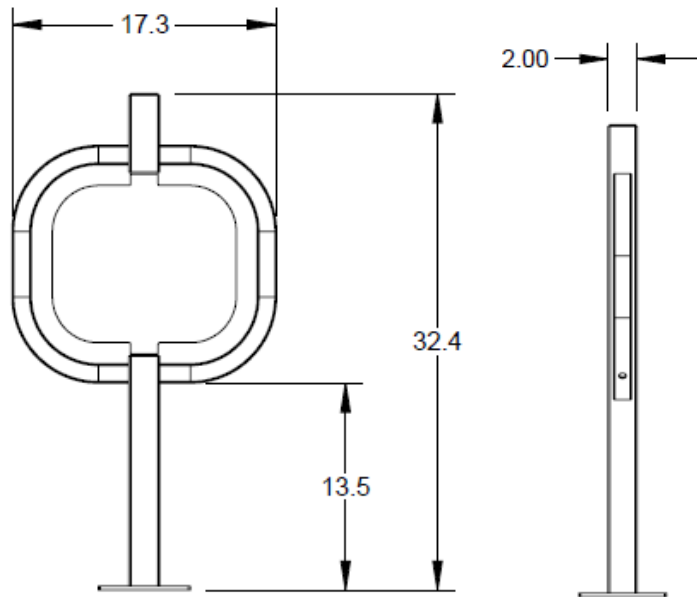
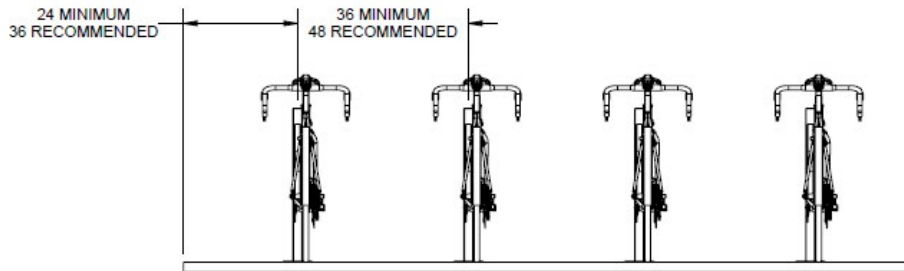
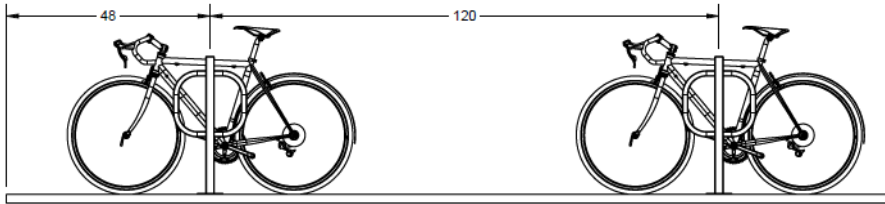

27923 Shown

Dimensions						
Model #	# Bikes	Type of Mount	Weight	Length	Height	Width
27923	2	Flange	24 lbs.	17.25"	32.37"	6"
27972	2	Below Grade	28 lbs.	17.25"	49.12"	2"



2 bikes



2" Square
1.25"



Powder Coat



Temporary: 28879
(install kit: 25683)
Temporary
Secure: 26270
(install kit: 26268)
Permanent: 6265



1 year
warranty



Made in
the USA

Anchors must be purchased separately



Standard Colors



Flange Mount

Our Saris Infrastructure representatives can assist with custom layout and spacing to meet your room dimensions and desired bike capacity.

Saris Infrastructure 800.783.7257

www.sarisinfrastructure.com

Downloadable product resources available online:



CAD Files



SketchUp Files



Written Specs



Photos